

Trend Line 600 FHTL 604 3G TC XS E Acier Inoxydable |

106.0183.093

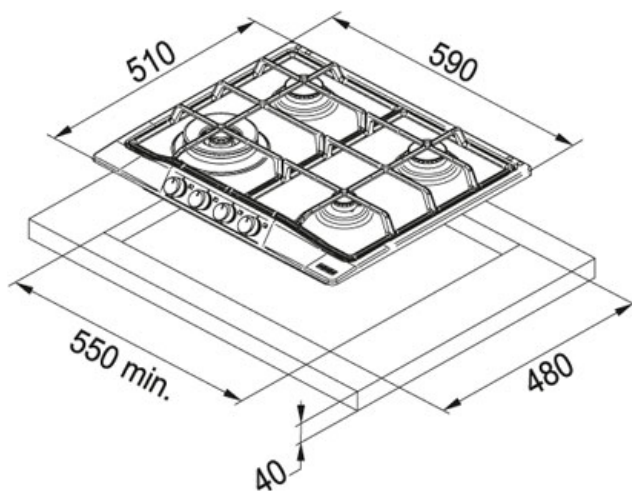





FAMILY : **Plaque de cuisson** | SERIE : **Trend Line 600** | MODEL : **FHTL 604 3G TC XS E** | FINISH : **Acier Inoxydable** |
INSTALLATION TYPE : **Encastrable**



TECHNICAL DATA

Nombre de feux	4
Puissance	Auxiliaire 1000W Semi-rapide 1750W Triple Couronne 3800W
Grilles	En émail
Longueur hors tout	590,00 mm
Largeur hors tout	510,00 mm
Longueur de la découpe	550,00 mm
Largeur de la découpe	480,00 mm
Cut-Out	550X480

FONCTIONS

	Allumage électrique intégré		Grilles en fonte (en option)
	Commandes (en option)		Valve de sécurité
	AISI 304		Nouveau
			4 Brûleurs

